

70

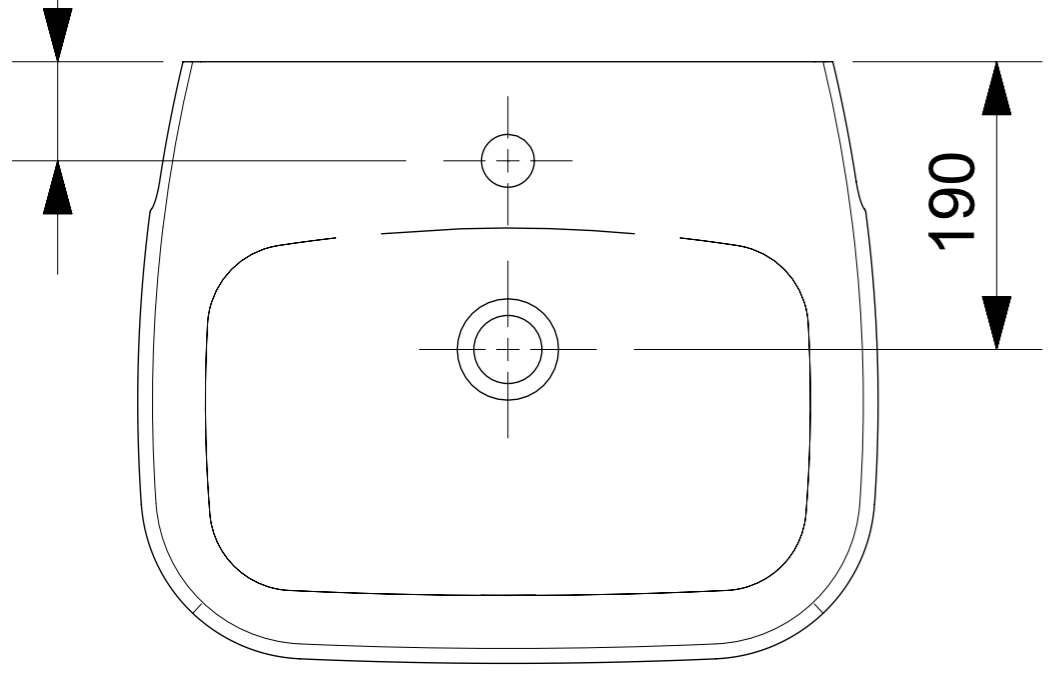

190

495

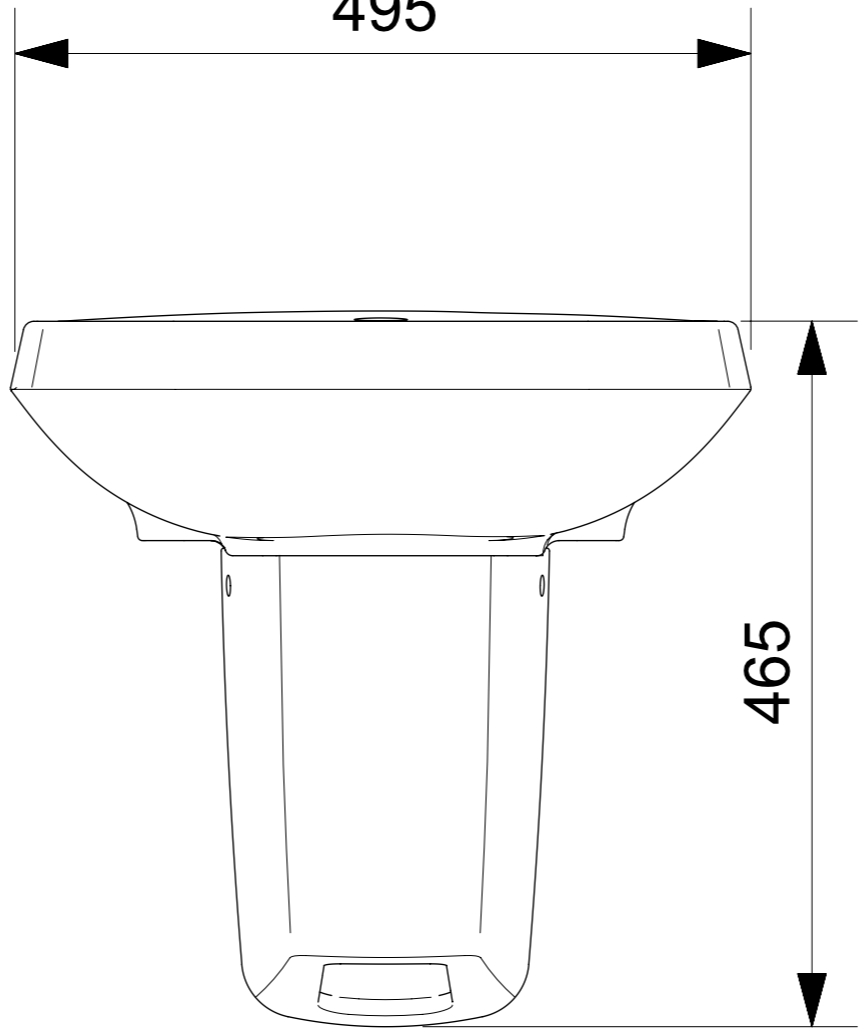

465

410

