

10151

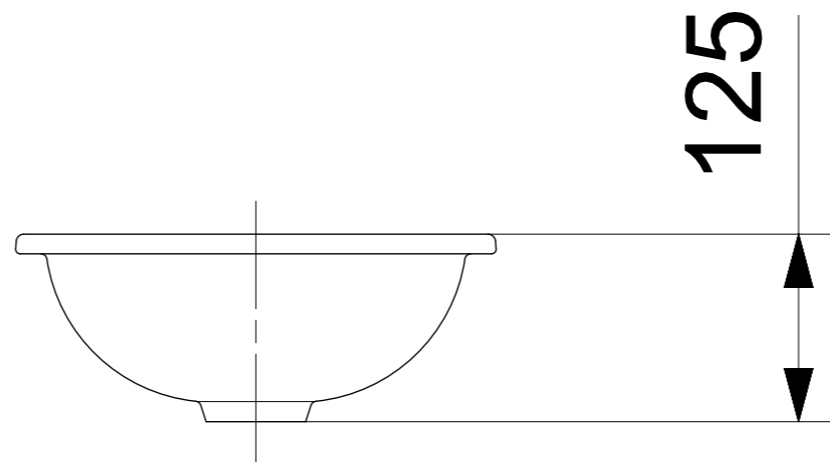
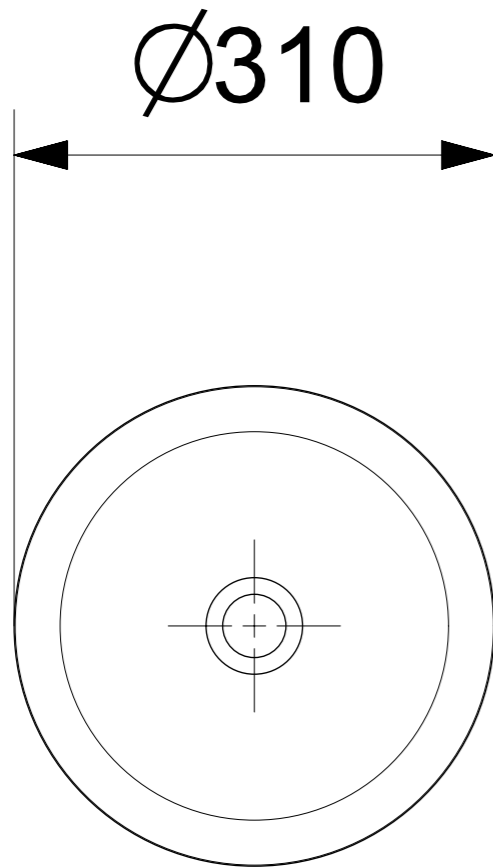

OBS.: Todas as medidas acima contém tolerância de +/- 10mm.