

25006

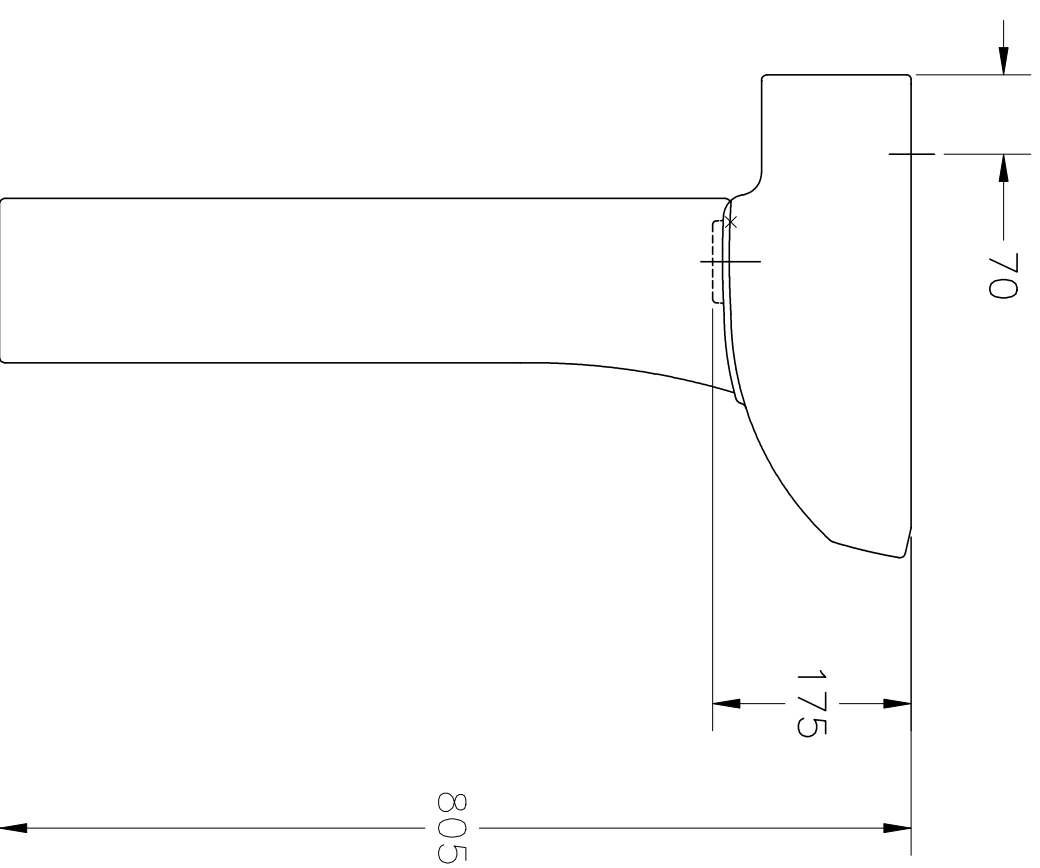
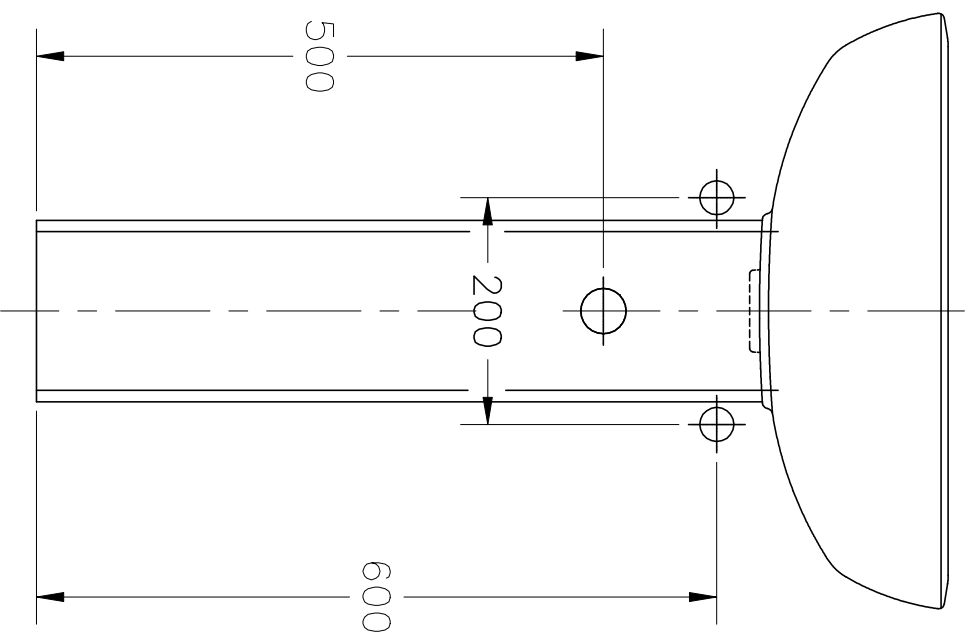
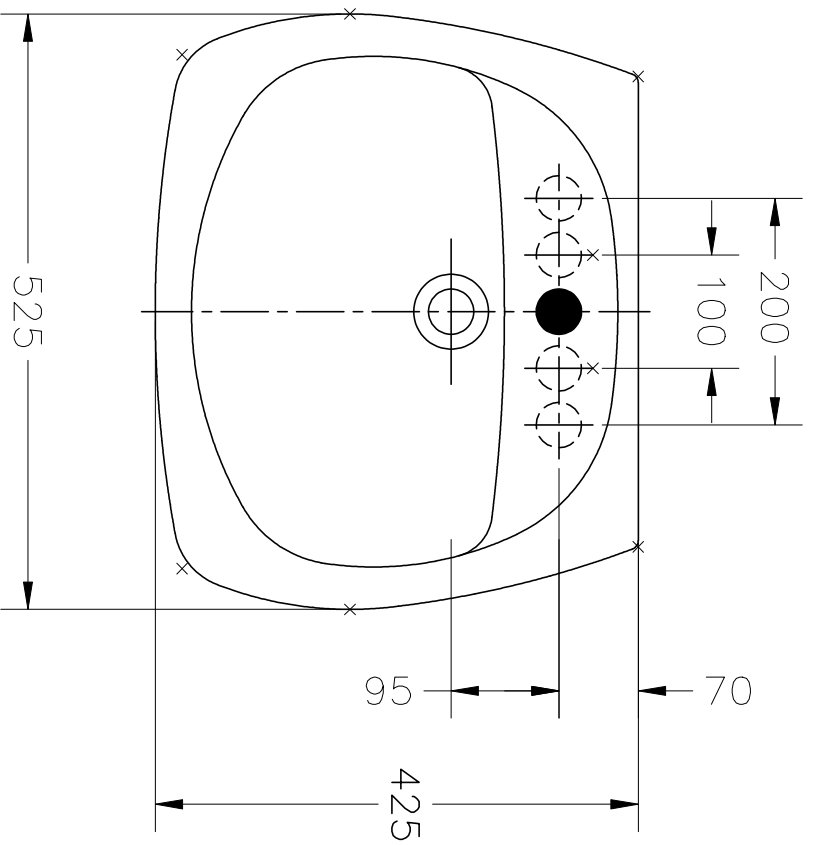

\* OBS: Todas as medidas acima contém tolerância de +/- 10 mm

**Incepa**

OFICINA TÉCNICA DE PRODUTOS