

25400

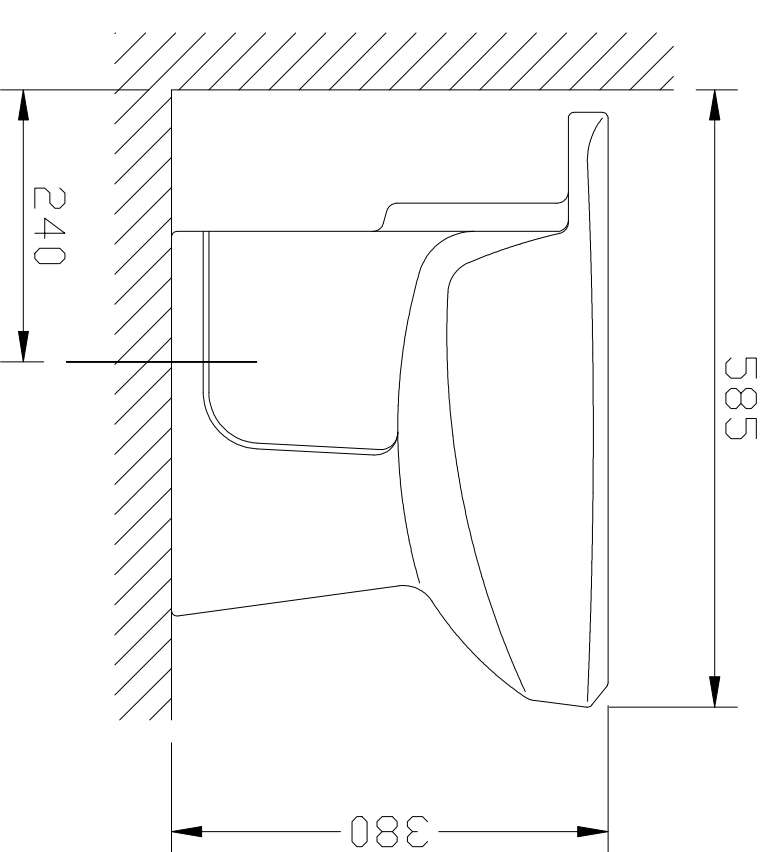
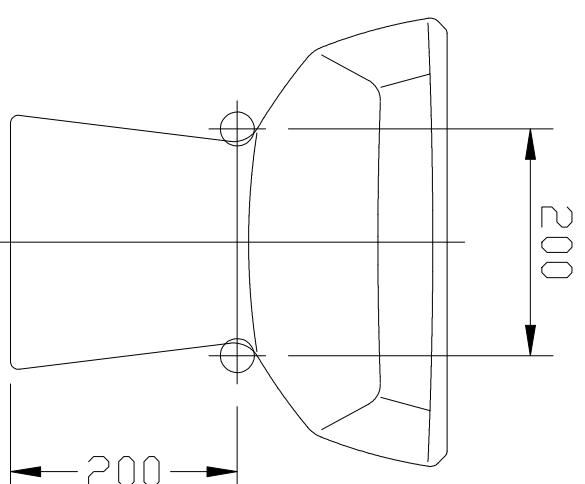
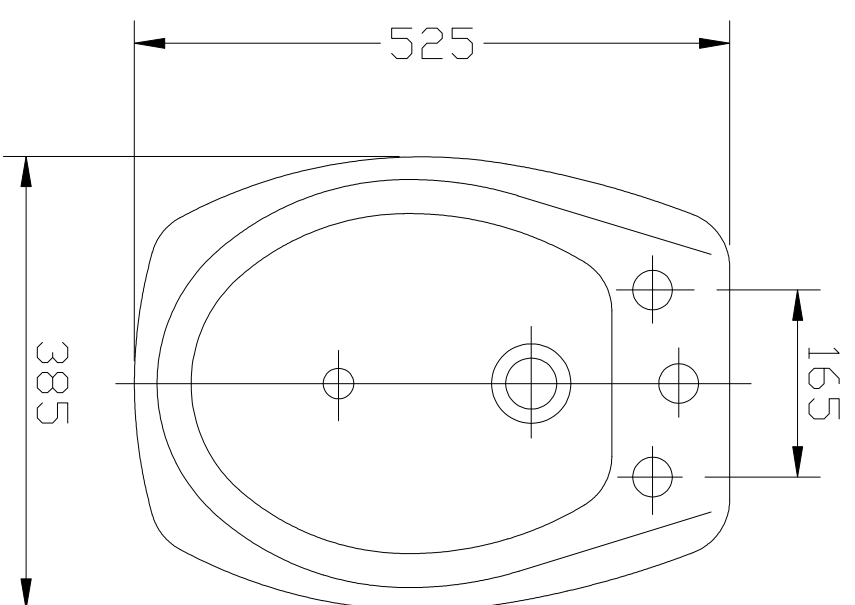

* OBS: Todas as medidas acima contém tolerância de +/- 10 mm

Incepa

OFICINA TÉCNICA DE PRODUTOS