

# 63174

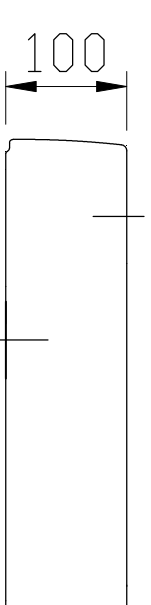
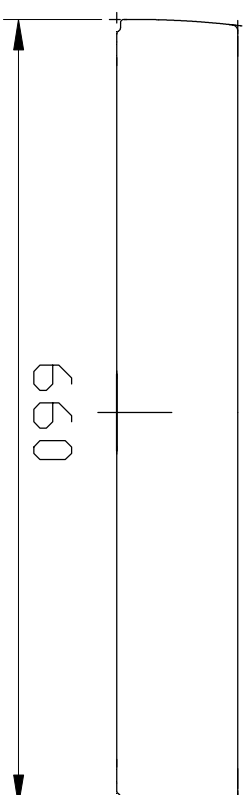
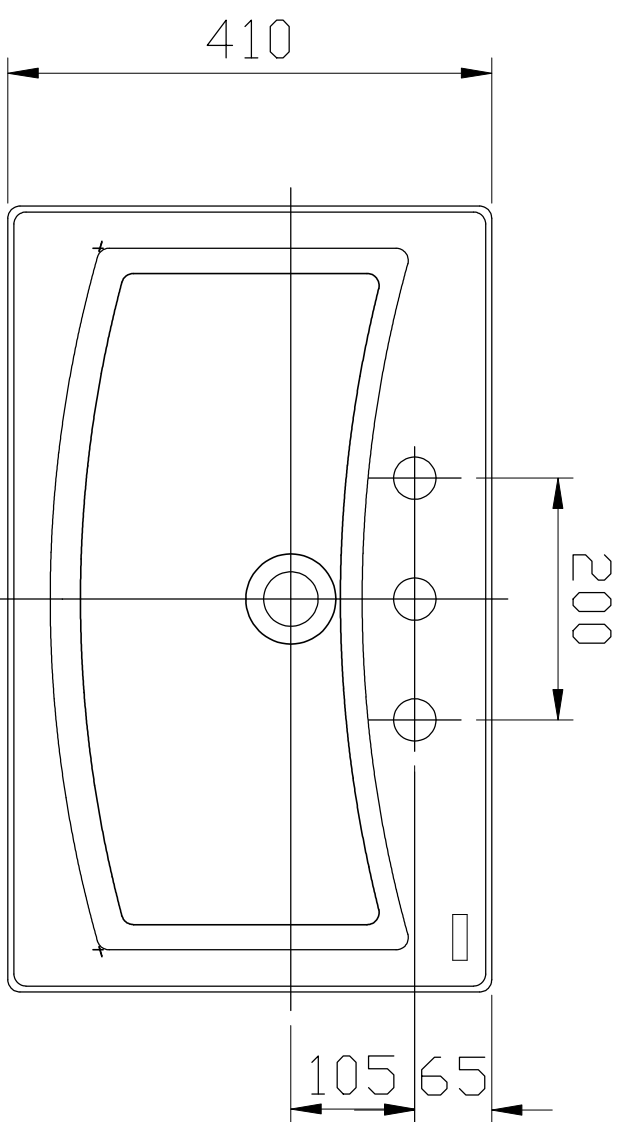

\* OBS: Todas as medidas acima contém tolerância de +/- 10 mm

## Incepa

OFICINA TÉCNICA DE PRODUTOS